

# Agilent M9381A PXIe Vector Signal Generator 1 MHz to 3 GHz or 6 GHz



## Startup Guide



**Agilent Technologies**

## Notices

© Agilent Technologies, Inc. 2013

No part of this manual may be reproduced in any form or by any means (including electronic storage and retrieval or translation into a foreign language) without prior agreement and written consent from Agilent Technologies, Inc. as governed by United States and international copyright laws.

### Manual Part Number

M9381-90001

### Edition

May 2013. build 2013.05.08.1610

Printed in USA

Agilent Technologies, Inc.

### Sales and Technical Support

To contact Agilent for sales and technical support, refer to the “support” links on the following Agilent web resources:

- [www.agilent.com/find/M9381A](http://www.agilent.com/find/M9381A) (product-specific information and support, software and documentation updates)
- [www.agilent.com/find/assist](http://www.agilent.com/find/assist) (world-wide contact information for repair and service)

Information on preventing damage to your Agilent equipment can be found at [www.agilent.com/find/tips](http://www.agilent.com/find/tips).

### Regulatory Compliance

This product has been designed and tested in accordance with accepted industry standards, and has been supplied in a safe condition. To review the Declaration of Conformity, go to <http://regulations.corporate.agilent.com/DoC/search.htm>.

### Warranty

**The material contained in this document is provided “as is,” and is subject to being changed, without notice, in future editions. Further, to the maximum extent permitted by applicable law, Agilent disclaims all warranties, either express or implied, with regard to this manual and any information contained herein, including but not limited to the implied warranties of merchantability and fitness for a particular purpose. Agilent shall not be liable for errors or for incidental or consequential damages in connection with the furnishing, use, or performance of this document or of any information contained herein. Should Agilent and the user have a separate written agreement with warranty terms covering the material in this document that conflict with these terms, the warranty terms in the separate agreement shall control.**

### Technology Licenses

The hardware and/or software described in this document are furnished under a license and may be used or copied only in accordance with the terms of such license.

### Restricted Rights Legend

If software is for use in the performance of a U.S. Government prime contract or sub-contract, Software is delivered and licensed as “Commercial computer software” as defined in DFAR 252.227-7014 (June 1995), or as a “commercial item” as defined in FAR 2.101(a) or as “Restricted computer software” as defined in FAR 52.227-19 (June 1987) or any equivalent agency regulation or contract clause. Use, duplication or disclosure of Software is subject to Agilent Technologies’ standard commercial license terms, and non-DOD Departments and Agencies of the U.S. Government will receive no greater than Restricted Rights as defined in FAR 52.227-19(c)(1-2) (June 1987). U.S. Government users will receive no greater than Limited Rights as defined in FAR 52.227-14 (June 1987) or DFAR 252.227-7015 (b)(2) (November 1995), as applicable in any technical data.

### Safety Notices

The following safety precautions should be observed before using this product and any associated instrumentation.

This product is intended for use by qualified personnel who recognize shock hazards and are familiar with the safety precautions required to avoid possible injury. Read and follow all installation, operation, and maintenance information carefully before using the product.

#### WARNING

**If this product is not used as specified, the protection provided by the equipment could be impaired. This product must be used in a normal condition (in which all means for protection are intact) only.**

The types of product users are:

- **Responsible body** is the individual or group responsible for the use and maintenance of equipment, for ensuring that the equipment is operated within its specifications and operating limits, and for ensuring operators are adequately trained.
- **Operators** use the product for its intended function. They must be trained in electrical safety procedures and proper use of the instrument. They must be protected from electric shock and contact with hazardous live circuits.
- **Maintenance personnel** perform routine procedures on the product to keep it operating properly (for example, setting the line voltage or replacing consumable materials). Maintenance procedures are described in the user documentation. The procedures explicitly state if the operator may perform them. Otherwise, they should be performed only by service personnel.
- **Service personnel** are trained to work on live circuits, perform safe installations, and repair products. Only properly trained service personnel may perform installation and service procedures.

Agilent products are designed for use with electrical signals that are rated Measurement Category I and Measurement Category II, as described in the International Electrotechnical Commission (IEC) Standard IEC 60664. Most measurement, control, and data I/O signals are Measurement Category I and must not be directly connected to mains voltage or to voltage sources with high transient over-voltages. Measurement Category II connections require protection for high transient over-voltages often associated with local AC mains connections. Assume all measurement, control, and data I/O connections are for connection to Category I sources unless otherwise marked or described in the user documentation.

Exercise extreme caution when a shock hazard is present. Lethal voltage may be present on cable connector jacks or test fixtures. The American National Standards Institute (ANSI) states that a shock hazard exists when voltage levels greater than 30V RMS, 42.4V peak, or 60VDC are present. A good safety practice is to expect that hazardous voltage is present in any unknown circuit before measuring.

Operators of this product must be protected from electric shock at all times. The responsible body must ensure that operators are prevented access and/or insulated from every connection point. In some cases, connections must be exposed to potential human contact. Product operators in these circumstances must be trained to protect themselves from the risk of electric shock. If the circuit is capable of operating at or above 1000V, no conductive part of the circuit may be exposed.

Do not connect switching cards directly to unlimited power circuits. They are intended to be used with impedance-limited sources. NEVER connect switching cards directly to AC mains. When connecting sources to switching cards, install protective devices to limit fault current and voltage to the card.

Before operating an instrument, ensure that the line cord is connected to a properly-grounded power receptacle. Inspect the connecting cables, test leads, and jumpers for

possible wear, cracks, or breaks before each use.

When installing equipment where access to the main power cord is restricted, such as rack mounting, a separate main input power disconnect device must be provided in close proximity to the equipment and within easy reach of the operator.

For maximum safety, do not touch the product, test cables, or any other instruments while power is applied to the circuit under test. ALWAYS remove power from the entire test system and discharge any capacitors before: connecting or disconnecting cables or jumpers, installing or removing switching cards, or making internal changes, such as installing or removing jumpers.

Do not touch any object that could provide a current path to the common side of the circuit under test or power line (earth) ground. Always make measurements with dry hands while standing on a dry, insulated surface capable of withstanding the voltage being measured.

The instrument and accessories must be used in accordance with its specifications and operating instructions, or the safety of the equipment may be impaired.

Do not exceed the maximum signal levels of the instruments and accessories, as defined in the specifications and operating information, and as shown on the instrument or test fixture panels, or switching card.

When fuses are used in a product, replace with the same type and rating for continued protection against fire hazard.

Chassis connections must only be used as shield connections for measuring circuits, NOT as safety earth ground connections.

If you are using a test fixture, keep the lid closed while power is applied to the device under test. Safe operation requires the use of a lid interlock.

#### CAUTION

A **CAUTION** notice denotes a hazard. It calls attention to an operating procedure, practice, or the like that, if not correctly performed or adhered to, could result in damage to the product or loss of important data. Do not proceed beyond a **CAUTION** notice until the indicated conditions are fully understood and met.

#### WARNING

A **WARNING** notice denotes a hazard. It calls attention to an operating procedure, practice, or the like that, if not correctly performed or adhered to, could result in personal injury or death. Do not proceed beyond a **WARNING** notice until the indicated conditions are fully understood and met.

Instrumentation and accessories shall not be connected to humans.

Before performing any maintenance, disconnect the line cord and all test cables.

To maintain protection from electric shock and fire, replacement components in mains circuits – including the power transformer, test leads, and input jacks – must be purchased from Agilent. Standard fuses with applicable national safety approvals may be used if the rating and type are the same. Other components that are not safety-related may be purchased from other suppliers as long as they are equivalent to the original component (note that selected parts should be purchased only through Agilent to maintain accuracy and functionality of the product). If you are unsure about the applicability of a replacement component, call an Agilent office for information.

#### WARNING

**No operator serviceable parts inside. Refer servicing to qualified personnel. To prevent electrical shock do not remove covers. For continued protection against fire hazard, replace fuse with same type and rating.**

## PRODUCT MARKINGS:



The CE mark is a registered trademark of the European Community.



The C-Tick mark is a registered trademark of the Australian Spectrum Management Agency.



This symbol indicates product compliance with the Canadian Interference-Causing Equipment Standard (ICES-001). It also identifies the product is an Industrial Scientific and Medical Group 1 Class A product (CISPR 11, Clause 4).



This symbol indicates separate collection for electrical and electronic equipment, mandated under EU law as of August 13, 2005. All electric and electronic equipment are required to be separated from normal waste for disposal (Reference WEEE Directive, 2002/96/EC).



This symbol on an instrument means caution, risk of danger. You should refer to the operating instructions located in the user documentation in all cases where the symbol is marked on the instrument.



This symbol indicates the time period during which no hazardous or toxic substance elements are expected to leak or deteriorate during normal use. Forty years is the expected useful life of the product.



This symbol indicates the instrument is sensitive to electrostatic discharge (ESD). ESD can damage the highly sensitive components in your instrument. ESD damage is most likely to occur as the module is being installed or when cables are connected or disconnected. Protect the circuits from ESD damage by wearing a grounding strap that provides a high resistance path to ground. Alternatively, ground yourself to discharge any built-up static charge by touching the outer shell of any grounded instrument chassis before touching the port connectors.

## CLEANING PRECAUTIONS:

### WARNING

**To prevent electrical shock, disconnect the Agilent Technologies instrument from mains before cleaning. Use a dry cloth or one slightly dampened with water to clean the external case parts. Do not attempt to clean internally. To clean the connectors, use alcohol in a well-ventilated area. Allow all residual alcohol moisture to evaporate, and the fumes to dissipate prior to energizing the instrument.**

# Table of Contents

---

Documentation Map .....	7
M9381A Introduction .....	8
Related Documentation .....	8
Follow the Startup Sequence .....	8
Step 1: Unpack and Inspect the Modules .....	9
ESD .....	9
Inspect for Damage .....	9
Return an Instrument for Service .....	9
Step 2: Verify M9381A Shipment Contents .....	10
Items included in your M9381A Shipment .....	10
M9381A Model – Option List .....	11
Step 3: Install the Software .....	11
System Requirements .....	11
Hardware Requirements .....	12
Power up the Controller .....	12
Software Installation Overview .....	12
Software Installation Procedure .....	13
Step 4: Install the Module .....	14
Recommended Practices for Temperature Control .....	14
Module Installation Procedure .....	14
M9381A Instrument Connections .....	16
Agilent M9381A PXIe Vector Signal Generator Cabling Diagram .....	16
Sharing the M9300A Frequency Reference .....	17
M9300A PXIe Frequency Reference Front Panel Features .....	19
M9301A PXIe Synthesizer Front Panel Features .....	20
M9310A PXIe Source Output Front Panel Features .....	21
M9311A PXIe Digital Vector Modulator Front Panel Features .....	22
M9381A Block Diagram .....	23
M9381A Block Diagram Reference Table for M9300A .....	24
M9381A Block Diagram Reference Table for M9301A .....	24
M9381A Block Diagram Reference Table for M9310A .....	25
M9381A Block Diagram Reference Table for M9311A .....	25
Step 5: Verify Operation of the Agilent M9381A PXIe Vector Signal Generator .....	26
Step 6: Installation is Complete .....	27
API Overview .....	27
IVI Drivers .....	27
LabVIEW Driver .....	27
M9381A Specifications .....	27
M9381A Troubleshooting .....	28
Communications .....	28
Status LED States .....	29
M9381A Soft Front Panel Self Tests .....	29
M9300A PXIe Frequency Reference Troubleshooting .....	30
M9301A PXIe Synthesizer Troubleshooting .....	31
M9310A PXIe Source Output Troubleshooting .....	33
M9311A PXIe Digital Vector Modulator Troubleshooting .....	34
Configuring M9018A PXIe Backplane Triggers .....	35



# Documentation Map

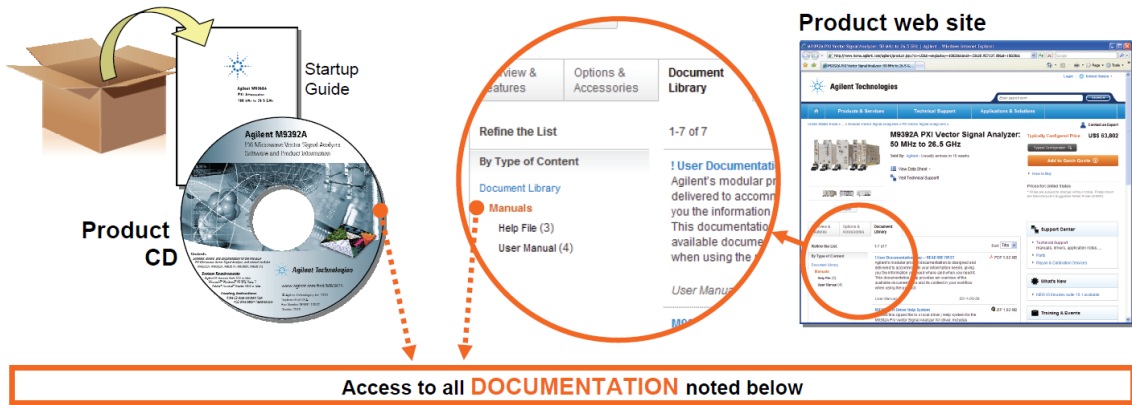

## Startup Guide



- Unpack product
- Verify shipment
- Install software
- Install hardware
- Verify operation
- Troubleshooting

## Data Sheet



- Product description
- Technical specifications

## Soft Front Panel (SFP) user interface

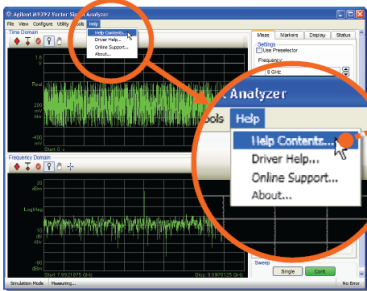

## SFP help system

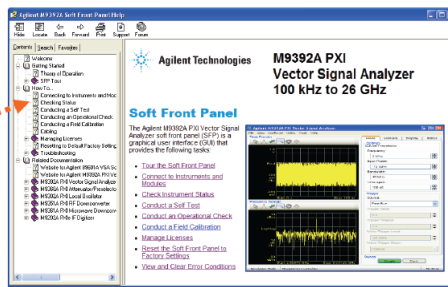

- Theory of operation
- Block diagram
- Configuration
- Self test
- Operational check
- Field calibration
- Troubleshooting

## Visual Studio

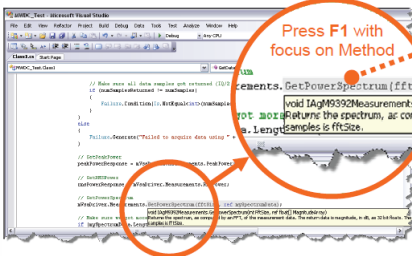

## IVI Driver help system

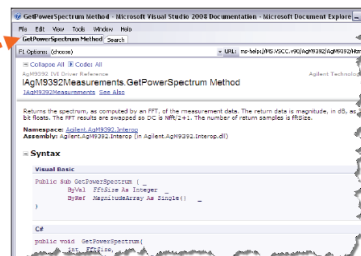

- IVI-COM and IVI-C driver programmer's reference
- Sample programs

## LabVIEW

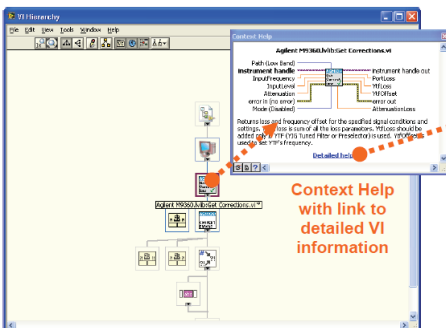

## LabVIEW Driver help system

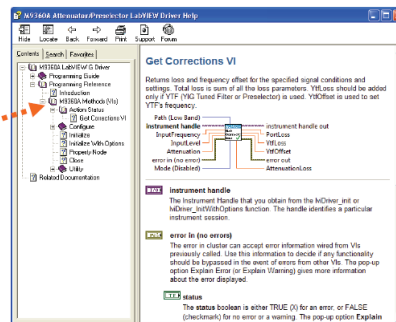

- LabVIEW driver programmer's reference
- Sample programs

# M9381A Introduction

The scope of this Startup Guide is to detail the processes of receiving and installing the software, modules and cables that comprise the Agilent M9381A PXIe Vector Signal Generator. Troubleshooting is included to assist you in determining and specifying any failures. If you have any questions after reviewing this information, please contact your local Agilent Technologies Inc. representative or contact us through our website at [www.agilent.com/find/M9381A](http://www.agilent.com/find/M9381A).

## Related Documentation

This Startup Guide and the documentation listed below are on the CD and at [www.agilent.com/find/M9381A](http://www.agilent.com/find/M9381A) (go to **Document Library** > **Manuals**).

- M9381A Soft Front Panel help system
- M9381A device driver API help systems (IVI-C/IVI-COM and LabVIEW G)
- M9381A Specifications Guide

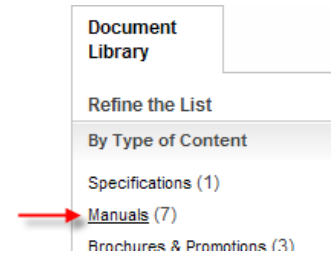

## Follow the Startup Sequence

**WARNING** Closely follow the startup process flow in this document. Deviating from the sequence can cause unpredictable system behavior, damage your system, and may cause personal injury.

### Step 1: Unpack and Inspect



### Step 2: Verify Shipment



### Step 3: Install Drivers and Software

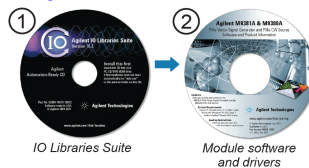

### Step 4: Install Modules

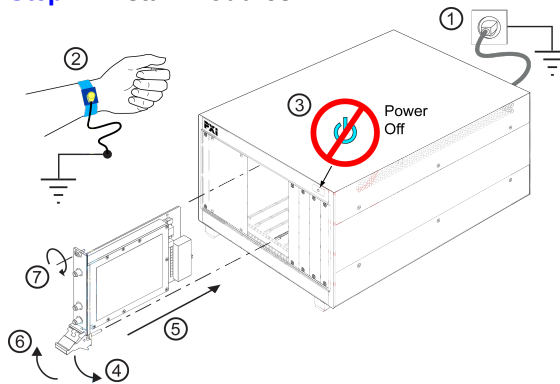

### Step 5: Verify Operation with the Soft Front Panel (SFP)

**Step 6: INSTALLATION PROCESS COMPLETE.**  
Proceed to program your product through the API.



## Step 1: Unpack and Inspect the Modules

**CAUTION**

The modules are shipped in materials which prevent damage from static. The modules should only be removed from the packaging in an anti-static area ensuring that correct anti-static precautions are taken. Store all modules in anti-static envelopes when not in use.

### ESD

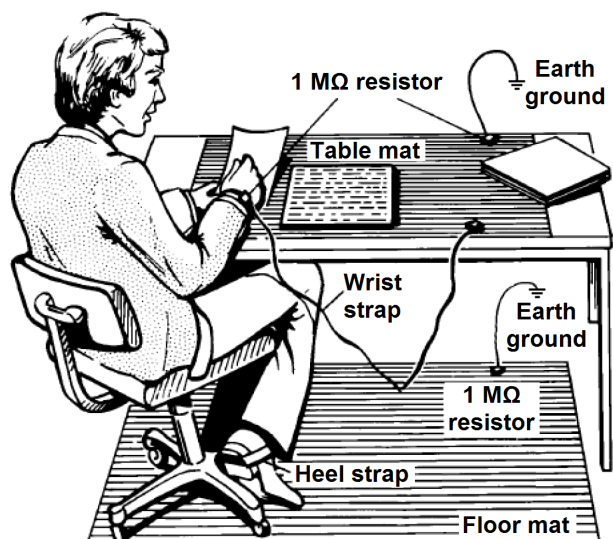

Electrostatic discharge (ESD) can damage or destroy electronic components. Use a static-safe work station to perform all work on electronic assemblies. The figure (left) shows a static-safe work station using two types of ESD protection: conductive table-mat and wrist-strap combination, and conductive floor-mat and heel-strap combination. Both types, when used together, provide a significant level of ESD protection. Of the two, only the table-mat and wrist-strap combination provides adequate ESD protection when used alone. To ensure user safety, the static-safe accessories must provide at least 1 MΩ of isolation from ground.

**WARNING**

**DO NOT** use these techniques for a static-safe work station when working on circuitry with a voltage potential greater than 500 volts.

### Inspect for Damage

After unpacking a module, inspect it for any shipping damage. Report any damage to the shipping agent immediately, as such damage is not covered by the warranty (see warranty information at beginning of this document).

**CAUTION**

To avoid damage when handling a module, do not touch exposed connector pins.

**NOTE**

See [www.agilent.com/find/tips](http://www.agilent.com/find/tips) for information on preventing damage to your Agilent equipment.

### Return an Instrument for Service

Should it become necessary to return an instrument for repair or service, follow the steps below:

**NOTE**

It is recommended that you return all modules and cables for repair and calibration. If your Agilent M9300A PXIe Frequency Reference is operating properly, you need not send it in with the other modules. Your instrument may be calibrated without your M9300A, as long as you use an M9300A as your frequency reference. Doing so, however, will effect your calibration schedule.

1. Review the warranty information shipped with your product.
2. Contact Agilent to obtain a Return Material Authorization (RMA) and return address. For assistance finding Agilent contact information, go to [www.agilent.com/find/assist](http://www.agilent.com/find/assist) (worldwide contact information for repair and service) or refer to the “Support” information on the product web page at [www.agilent.com/find/M9381A](http://www.agilent.com/find/M9381A).
3. Write the following information on a tag and attach it to the malfunctioning equipment:

## Step 2: Verify M9381A Shipment Contents

- Name and address of owner. A P.O. box is not acceptable as a return address.
  - Module serial number(s). The serial number label is located on the side panel of the module. The serial number can also be read from the Soft Front Panel interface – after the hardware is installed.
  - Description of failure or service required.
4. Pack the instrument in its original packaging material. Include all cables. If the original packaging material is not available, use bubble wrap or packing peanuts and place the instrument in a sealed container and mark the container “FRAGILE”.
  5. On the shipping label, write ATTENTION REPAIR DEPARTMENT and the RMA number.

### NOTE

If any correspondence is required, refer to the product by serial number and model number.

## Step 2: Verify M9381A Shipment Contents

The Agilent M9381A PXIe Vector Signal Generator is a collection of modules, housed in a PXIe chassis. The minimum Vector Signal Generator consists of the software, chassis, an Agilent M9301A PXIe Synthesizer, an Agilent M9310A PXIe Source Output, an Agilent M9311A PXIe Digital Vector Modulator and an Agilent M9300A PXIe Frequency Reference. The M9300A may be used in this and other configurations. You may configure the Agilent M9380A PXIe CW Source in the same chassis and also use the same M9300A.

### Items included in your M9381A Shipment

Qty	Part Number	Description
1	M9300-10002	Software and Product Information CD, contains: Soft Front Panels, drivers, and all printed documentation in PDF format. (also available at <a href="http://www.agilent.com/find/M9381A">http://www.agilent.com/find/M9381A</a> )
1	E2094-60003	Agilent IO Libraries Suite CD
1	M9381-90001	Agilent M9381A PXIe Vector Signal Generator Startup Guide in hard copy
1	5023-1450	Wrench, socket, extension, 5/16 inch, SMA
1	5002-3361	SMB/MMCX Cable Removal Tool
3	1810-0118	SMA (m) straight, 50 Ω termination. These are attached to the M9301A RF/LO ports.
1 *	M9300A	(Optional) Agilent M9300A PXIe Frequency Reference
1	M9301A	Agilent M9301A PXIe Synthesizer
1	M9310A	Agilent M9310A PXIe Source Output
1	M9311A	Agilent M9311A PXIe Digital Vector Modulator
1	5972-3335	PXI Modular Product Startup Guide Reference
1	9320-6691	China ROHS Addendum for Signal Generator
1	5962-0476	Certificate of Calibration
1	5959-4660	Recommended Due Date for Adjustment/Calibration
1	8121-2063	Cable, coaxial, BNC/male-SMB/female, 1200 mm
4	8120-5091	Cable, coaxial, SMB-SMB (120 mm)
1	1250-2316	Adaptor, coaxial, straight, SMA (f) to SMA (m)
1	W1312-20266	Cable, semi-rigid, (SMA-SMA)
1	W1312-20267	Cable, semi-rigid, (SMA-SMA)
4	W1312-20265	Cable, coaxial, SMB-SMB (85 mm)

\* The Agilent M9300A PXIe Frequency Reference is required to configure an Agilent M9381A PXIe Vector Signal Generator. It is an option to the M9381A because it may be ordered in, and shared by, the M9380A instrument.

## M9381A Model – Option List

The following table lists the available options for the Agilent M9381A PXIe Vector Signal Generator.

### Model – Option List for the Agilent M9381A PXIe Vector Signal Generator

M9381A	Description
M9381A	PXIe C W Source: 1 MHz to 3 GHz or 6 GHz
M9381A-F03	Frequency Range, 1 MHz to 3 GHz
M9381A-F06	Frequency Range: 1 MHz to 6 GHz
M9381A-1EA	High Output Power
M9381A-UNZ	Fast Switching
M9381A-B04	RF Modulation Bandwidth, 40 MHz
M9381A-B10	RF Modulation Bandwidth, 100 MHz
M9381A-B16	RF Modulation Bandwidth, 160 MHz
M9381A-M01	Memory, 32 MSa
M9381A-M05	Memory, 512 MSa
M9381A-M10	Memory, 1024 MSa
M9381A-UNT	Analog Modulation
*M9381A-300	Agilent M9300A PXIe Frequency Reference: 10 MHz and 100 MHz
M9381A-UK6	Commercial calibration certificate with test data

\* The Agilent M9300A PXIe Frequency Reference is required to configure an Agilent M9381A PXIe Vector Signal Generator. It is an option to the M9381A because it may be ordered in, and shared by, the M9380A instrument.

## Step 3: Install the Software

### System Requirements

Topic	Windows® 7 and Vista Requirements	Windows® XP Requirements
Operating system	Windows 7 (32 bit and 64 bit); Windows® Vista, SP1 and SP2 (32-bit and 64-bit)	Window® XP, Service Pack 3
Processor speed	1 GHz 32-bit (x86), 1 GHz 64-bit (x64), no support for Itanium64	600 MHz or higher required 800 MHz recommended
Available memory	4 GB minimum (8 GB recommended)	3 GB minimum
Available disk space	1.5 GB available hard disk space, includes: <ul style="list-style-type: none"> <li>• 1 GB available for Microsoft .NET Framework 3.5 SP1 <sup>2</sup></li> <li>• 100 MB for Agilent IO Libraries Suite</li> </ul>	
Video	Support for DirectX 9 graphics with 128 MB graphics memory recommended (Super VGA graphics is supported)	Super VGA (800x600) 256 colors or more
Browser	Microsoft® Internet Explorer 7.0 or greater	Microsoft® Internet Explorer 6.0 or greater

<sup>1</sup> This is the required disk space for installation. Typically, less disk space is required for operation than is required for installation.

<sup>2</sup> .NET Framework Runtime Components are installed by default with Windows 7 and Vista. Therefore, you may not need this amount of disk space.

## Hardware Requirements

Topic	Requirements
Chassis	PXle or PXI-H chassis slot
Host controller	A PXI or PXI Express embedded controller or remote controller (external PC connected to the chassis by a PCI-to-PXI interface) is required.
Embedded controller	Agilent M9036A or an embedded controller that meets the following requirements: <ul style="list-style-type: none"> <li>• PXIe system controller (PXI-1 embedded controllers are not compatible)</li> <li>• Utilize a 2x8, 4x4, or 1x4 PXIe system slot link configuration.</li> <li>• Run one of the operating systems listed in System Requirements (above).</li> </ul>
Remote controller	(for Agilent M9018A chassis use only) Agilent M9021 Cable Interface x8 with one of the following PC interface options: <ul style="list-style-type: none"> <li>• Agilent <a href="#">M9045B</a> PCIe ExpressCard Adaptor x1, with cable (for a laptop PC)</li> <li>• Agilent <a href="#">M9048A</a> PCIe Desktop Adaptor x8, with cable (for desktop PCs)</li> </ul> Or an equivalent remote controller using a PC running one of the operating systems listed in System Requirements (above).

## Power up the Controller

**CAUTION**

If you are using a remote controller and you have installed the interface cable, you must power up the chassis **BEFORE** you power up the PC. When you power down your chassis, Shut Down the PC **BEFORE** you power down the chassis.

If you are using an embedded controller, complete the following steps:

1. Install the embedded controller module into the compatible chassis. The Agilent M9036A PXIe Embedded Controller and Agilent M9018A PXIe Chassis are recommended. Please refer to the embedded controller and chassis documentation for further details.
2. Connect peripherals (mouse, keyboard, monitor).
3. Power up the chassis.

## Software Installation Overview

This installation includes the following:

- Agilent IO Libraries Suite (IOLS), which includes the Agilent Connections Expert. This software is included with your shipment (CD part number E2094-60003), and is also available at [www.agilent.com/find/iosuite](http://www.agilent.com/find/iosuite). This software must be installed first.

**NOTE**

Version 16.3.16603.3 (or newer) of the Agilent IO Libraries Suite is required.

- Instrument software, which includes the SFP, device drivers (IVI-C, IVI-COM, and LabVIEW G) and documentation for the M9381A PXIe Vector Signal Generator. This software is included with your shipment (CD part number M9300-10002, and is also available at [www.agilent.com/find/M9381A](http://www.agilent.com/find/M9381A).

## Software Installation Procedure

1. Install the Agilent IO Libraries Suite from the Agilent IO Libraries Suite CD (E2094-60003) provided in your ship kit. Follow the installer prompts to install the IO libraries.
2. Install the M9381A product software:
  - a. Using the Agilent M9381A and M9380A PXIe Vector Signal Generator and PXIe CW Source Software and Product Information CD (M9300-10002), launch the installer.
  - b. Using the Agilent M9391A PXIe Vector Signal Analyzer Software and Product Information CD (M9391-10002), launch the installer.
  - c. Follow the installer prompts. Choose a "Complete" installation to install all software and documentation, or a "Custom" installation to select from a listing of modules and other features.

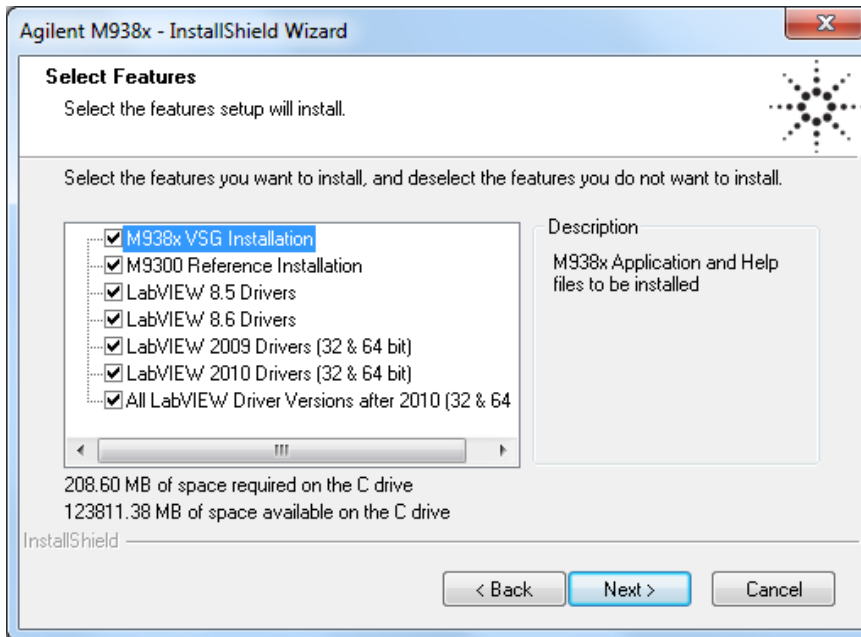

- d. **IMPORTANT:** In the Installation Complete prompt, select "**No, I will restart my computer later**" and then click the "**Finish**" button.



3. Power down the host PC.

### CAUTION

If you are using a remote controller, Shut Down the PC **BEFORE** you power down the chassis. When you restore power, power up the chassis **BEFORE** you power up the PC.

## Step 4: Install the Module

### CAUTION

PXI hardware does not support "hot-swap" (changing modules while power is applied to the chassis) capabilities. Before installing or removing a module to/from the chassis, power off the chassis to prevent damage to the module.

### NOTE

This module can be used in a chassis with PXIe or PXI-H chassis slot.

## Recommended Practices for Temperature Control

- Use slot blockers and EMC filler panels in empty module slots to assure proper operating temperatures.
- At ambient temperatures above 45° C (113° F) set the chassis fan to High.
- The use of an Agilent M9018A Chassis and slot blockers optimizes module temperature performance.

## Module Installation Procedure



The module can be installed in any PXIe or hybrid PXI slot marked with a peripheral slot compatibility image (solid black circle for PXIe, or solid black circle with the letter "H" for hybrid).

1. Make sure that the line cord is plugged in to establish earth ground and that the chassis power switch is Off.
2. If the chassis has multiple fan speed settings, ensure that the fan switch is set to **AUTO**.
3. Position the chassis to provide ample space between the chassis fan intake and exhaust vents. Blockage by walls or obstructions affects the air flow needed for cooling. (Refer to the chassis documentation for more information about cooling).
4. Before inserting the modules into the chassis, back the mounting screws out to ensure that there is no interference between the screws and the mounting rails.
5. See "[M9381A Instrument Connections](#)" on page 16 for positioning of the M9381A modules. Install the left-most module first and then proceed installing modules from left to right.

### CAUTION

The M9381A uses peer-to-peer (module-to-module) triggering across the PXI Express chassis backplane. Therefore, be sure to install the M9381A modules into a chassis that supports peer-to-peer PXI Express I/O switch topology. When using the Agilent M9018A PXIe 18-Slot Chassis, install the M9381A modules into one of its three slot groups: 1 through 6, 7 through 12, or 13 through 18. Unless you install the M9381A modules entirely within one of the slot groups, you will experience trigger errors. If you install the modules across (straddling) any of these groups of slots, you will have to reconfigure the chassis's PXIe trigger bus routing for trigger 6 and trigger 7. (EXCEPTION: You can install the M9300A Reference module in a different slot group, thus allowing one M9300A module to provide an RF reference across slot groups to one or more modular instruments.) For details on reconfiguring the M9018A chassis triggers see "[Configuring M9018A PXIe Backplane Triggers](#)" on page 35, or see the [Agilent M9018A Chassis documentation](#). If you are using a non-Agilent chassis, consult your manufacturer's documentation.

6. Holding the module by the injector/ejector handle, slide it into an available PXI (or hybrid) slot, as shown in the following figure.

- a. Install the module into the slot of the chassis by placing the module card edges into the front module guides (top and bottom).
- b. Slide the module to the rear of the chassis and ensure that the injector/ejector handle is pushed down in the unlatched (downward) position.
- c. Slide the module completely into the chassis. When you begin to feel resistance, pull up on the injector/ejector handle to fully inject the module into the chassis.

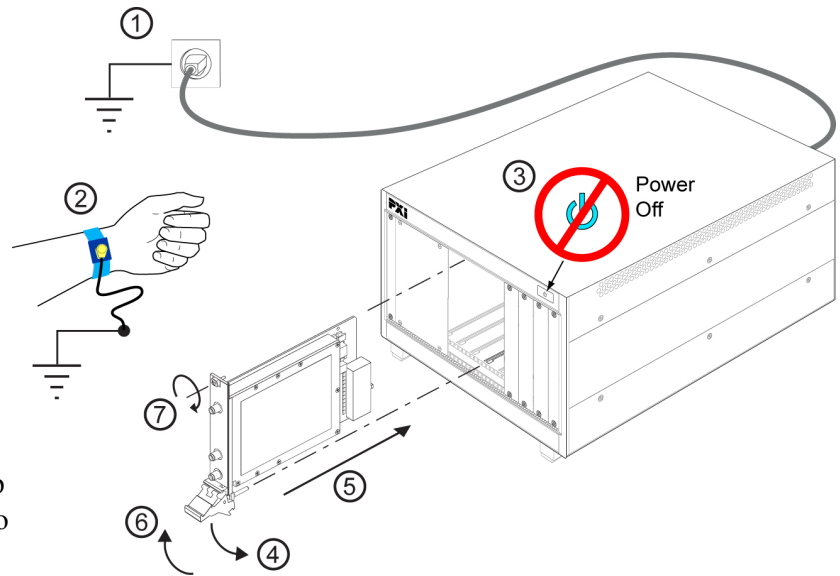

7. Secure the front panel to the chassis using the two module front-panel mounting screws. Performance may suffer if the screws are not tightened properly.
8. Verify that the PXI chassis fans are operable and free of dust and other contaminants that may restrict airflow.
9. Install filler panels and slot blockers after installing the module. Missing filler panels or slot blockers may disrupt air circulation in the chassis.
10. Your shipment included an Agilent M9310A PXIe Source Output. With this module you received a straight, coaxial adapter (1250-2316) (SMA female to SMA male). Connect this adapter to the RF Out connector of the M9310A and torque to 8 Lb-In (0.904 Nm). This will extend the life of this often-used connector.
11. Use the Cabling Diagram plus the Cable and Module Table on the next page to attach the cables to the instrument. The torque specification for SMA connectors is 8 Lb-In (0.904 Nm).
12. If you are using a PCIe Cable Interface, such as the Agilent M9021, connect the Cable Interface in the chassis to the PC host per the instructions that came with the Cable Interface.
13. Power up the PXI chassis.
14. Reboot the PC host.
15. Proceed to [Step 5: Verify Operation of the Agilent M9381A PXIe Vector Signal Generator](#) (page 26).

**Step 4: Install the Module**

**M9381A Instrument Connections**

This section contains a cabling diagram for the Agilent M9381A PXIe Vector Signal Generator, a cable and module association table, a table of Front Panel Features for each module, and a block diagram for the M9381A, with reference tables for each module.

**Agilent M9381A PXIe Vector Signal Generator Cabling Diagram**

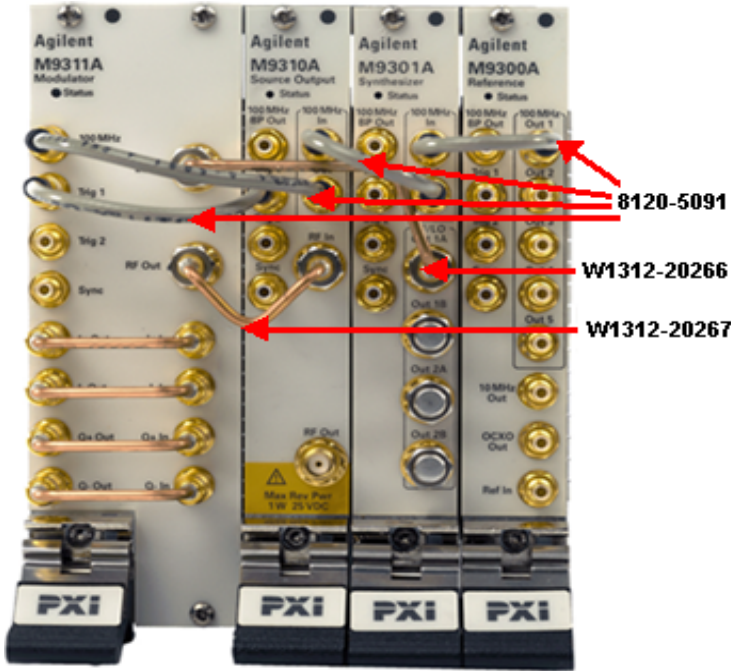

**Recommendation:** Install the semi-rigid cables first.

For front panel feature descriptions of the M9300A, see "[M9300A PXIe Frequency Reference Front Panel Features](#)" on page 19.

For front panel feature descriptions of the M9301A, see "[M9301A PXIe Synthesizer Front Panel Features](#)" on page 20.

For front panel feature descriptions of the M9310A, see "[M9310A PXIe Source Output Front Panel Features](#)" on page 21.

For front panel feature descriptions of the M9311A, see "[M9311A PXIe Digital Vector Modulator Front Panel Features](#)" on page 22.

**M9381A Cable and Module Table**

Part Number	Connection	Cable Description
8121-2063	This cable can be used to direct an External Reference into the M9300A Ref In connector.	Cable, coaxial, BNC (male) - SMB (female), 1200 mm
8120-5091	M9300A 100 MHz Out 1 to M9301A 100 MHz In	Cable, coaxial, SMB (female)-SMB (female)
8120-5091	M9301A 100 MHz Out to M9310A 100 MHz In	Cable, coaxial, SMB (female)-SMB (female)
8120-5091	M9310A 100 MHz Out to M9311A 100 MHz In	Cable, coaxial, SMB (female)-SMB (female)
8120-5091	M9310A Trig 1 to M9311A Trig 1 for Pulse Modulation	Cable, coaxial, SMB (female)-SMB (female)
W1312-20266	M9301A RF/LO Out 1A to M9311A LO In	Cable, semi-rigid, SMA (male) - SMA (male)
W1312-20267	M9311A RF Out to M9310A RF In	Cable, semi-rigid, SMA (male) - SMA (male)

**Torque specification** for all SMA connectors is 8 Lb-In (0.904 Nm).



## Sharing the M9300A Frequency Reference

The M9300A Frequency Reference module can be shared by up to four configurations of the M9380A CW Source, the M9381A Vector Signal Generator, or The M9391A Vector Signal Analyzer. If you connect to a hardware configuration that includes a currently connected M9300A (either independently or as part of another hardware configuration) the latest instance of the SFP will take control of the M9300A. You will see no warning or error message.

### CAUTION

While the M9300A module is being shared, any of the configurations that share this reference can control it fully, including setting the reference to use an external frequency reference source. If the external frequency reference setting does not match that of the supplied frequency, the reference will be unlocked, as expected. However, only the instance of the SFP that creates the reference unlock condition can correct the problem. This is done by either correcting the frequency or by setting the reference back to internal, so that a subsequent instance will not take control of the reference module unintentionally.

### CAUTION

The Reference module can also be shared among multiple measurement applications, such as the Agilent 89600 VSA software. The Reference module must be initialized before use, so including it in all configurations allows applications to be started in any order. However, when sharing a module the user interface of some applications may not reflect Reference module settings made by other applications. For example, the Agilent 89600 software can control the Reference module internal/external setting, but the changes made by other applications will not be reflected in the Agilent 89600.

### NOTE

FPGA upgrades are not allowed on shared M9300A frequency references.

## Reserving the Reference for a Configuration

If you are running a test in the background with a certain M9300A setting and then connect a hardware configuration that also contains the same M9300A, you may alter the test setup that is already running.

If you would prefer to be keep the reference control with the first instance of the hardware configuration so that a subsequent instance will not take control of the reference module unintentionally:

1. Click the **Advanced** control to open the **Options:** dialog.
2. Type the following string: `ShareReferenceVisaSession=0`

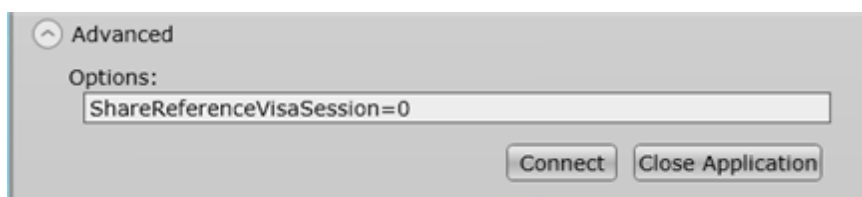

#### Step 4: Install the Module

This configuration will retain control of the M9300A if you try to open a new configuration. If you connect a new configuration, that includes the same M9300A, you will see the following error:

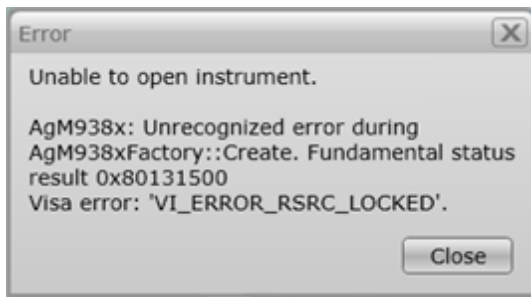

#### CAUTION

If an existing instance of the SFP is connected to the reference module in a shared (default) mode, but a second instance of the SFP connects to the same reference with the `ShareReferenceVisaSession=0` Advanced Option, the first instance will not only completely lose control of the reference, but may also lose its ability to read the reference status.

#### SMB and MMCX Cable and Connector Care

Use the Agilent SMB/MMCX Cable Removal Tool to disconnect SMB and MMCX cables from the module front panel connectors.

#### CAUTION

To avoid damage to the cables or connectors, pull the cable straight away from the connector. Do not use the tool as a pry bar.

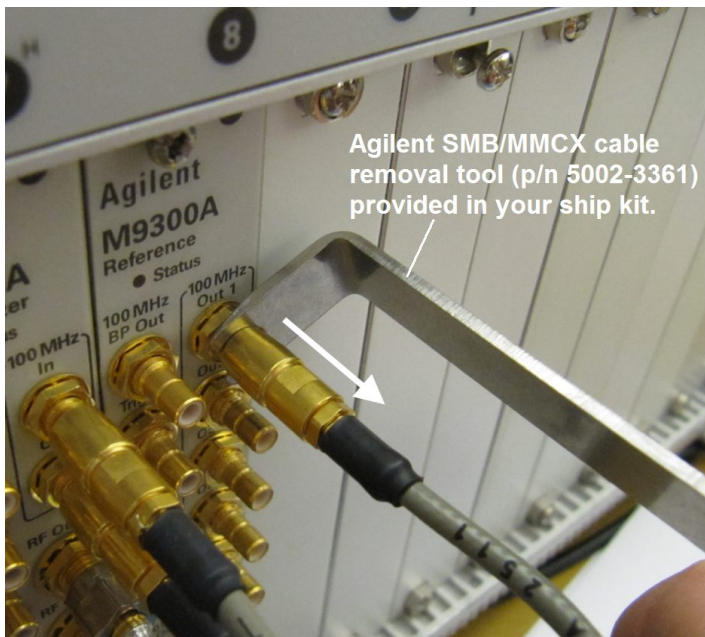

## M9300A PXIe Frequency Reference Front Panel Features

For parameter limits and specifications on the M9300A, see "[M9381A Block Diagram Reference Table for M9300A](#)" on page [24](#).

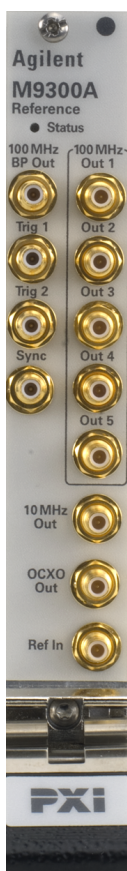

Connector	Description
<b>100 MHz BP Out</b>	This SMB male connector outputs a 100 MHz signal from the chassis backplane board. This output is enabled through the SFP.
<b>100 MHz Out 1 through Out 5</b>	Each of these SMB male connectors may output a 100 MHz reference signal to the 100 MHz In connector of the Agilent M9301A PXIe Synthesizer.
<b>Trig 1</b>	This connector is intended for future use.
<b>Trig 2</b>	This connector provides a programmable output trigger.
<b>Sync</b>	This connector is intended for future use.
<b>10 MHz Out</b>	This SMB male connector provides a 10 MHz signal. This output is enabled through the SFP.
<b>OCXO Out</b>	This SMB male connector provides a 10 MHz signal from the 10 MHz OCXO timebase. This output is enabled through the SFP.
<b>Ref In</b>	This SMB male connector inputs a 1 MHz to 110 MHz reference signal. The connector is AC coupled and terminated into 50 $\Omega$ .

Step 4: Install the Module

## M9301A PXIe Synthesizer Front Panel Features

For parameter limits and specifications on the M9301A connectors, see "[M9381A Block Diagram Reference Table for M9301A](#)" on page 24



Connector	Description
<b>100 MHz BP Out</b>	This SMB male connector outputs a 100 MHz signal from the chassis backplane.
<b>100 MHz In</b>	This SMB male connector inputs a 100 MHz reference signal from the 100 MHz Out connectors of the Agilent M9300A PXIe Frequency Reference.
<b>100 MHz Out</b>	This SMB male connector outputs the 100 MHz Reference signal to the Agilent M9310A PXIe Source Output 100 MHz In connector.
<b>Trig 1</b>	This SMB male connector accepts the External Input Trigger.
<b>Trig 2</b>	This SMB male connector is the List End Output Trigger.
<b>Sync</b>	This connector is intended for future use.
<b>RF/LO Out 1A, 1B, 2A, 2B</b>	These SMA female connectors (1A and 1B) are used to provide the LO In signal to the Agilent M9311A PXIe Digital Vector Modulator. Connectors 2A and 2B are intended for future use. Unused connectors should be terminated with the provided 50 Ω loads.

## M9310A PXIe Source Output Front Panel Features

For parameter limits and specifications on the M9310A connectors, see "[M9381A Block Diagram Reference Table for M9310A](#)" on page [25](#).



Connector	Description
<b>100 MHz BP Out</b>	This SMB male connector outputs a 100 MHz signal from the chassis backplane.
<b>100 MHz In</b>	This SMB male connector inputs a 100 MHz reference signal from the 100 MHz Out connectors of the Agilent M9301A PXIe Synthesizer.
<b>100 MHz Out</b>	This SMB male connector outputs the 100 MHz Reference signal to the Agilent M9311A PXIe Digital Vector Modulator 100 MHz In connector, in the M9381A configuration..
<b>Trig 1</b>	This SMB male connector accepts the Pulse RF Blanking Input Trigger from the M9311A Trig 1 connector.
<b>Trig 2</b>	This SMB male connector is the Source Settled Output Trigger.
<b>Sync</b>	This connector is intended for future use.
<b>RF In</b>	This SMA female connector inputs the RF signal from the Agilent M9311A PXIe Digital Vector Modulator RF Out connector.
<b>RF Out</b>	This SMA female connector outputs a Modulated RF signal of 1 MHz to 3 or 6 GHz.

### CAUTION

To avoid damage, do not exceed 1 Watt (25 VDC) reverse power into the M9310A RF Out connector.

Step 4: Install the Module

## M9311A PXIe Digital Vector Modulator Front Panel Features

For parameter limits and specifications on the M9311A connectors, see "[M9381A Block Diagram Reference Table for M9311A](#)" on page 25.

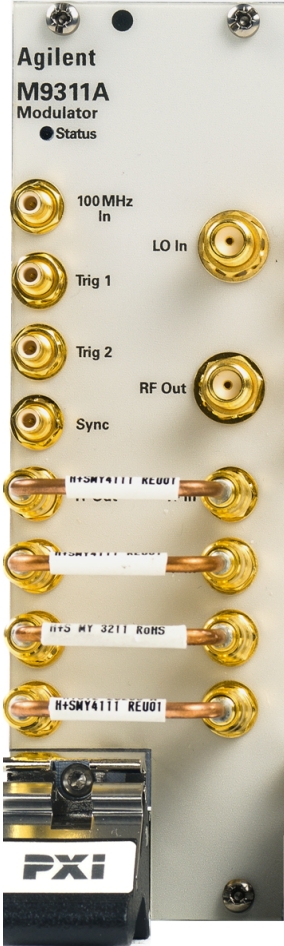

Connector	Description
<b>100 MHz In</b>	This SMB male connector inputs a 100 MHz reference signal from the 100 MHz Out connectors of the Agilent M9310A PXIe Source Output.
<b>LO In</b>	This SMA female connector inputs the LO signal from the Agilent M9301A PXIe Synthesizer RF/LO Out connector.
<b>Trig 1</b>	This SMB male connector is the Pulse RF Blanking Output Trigger. The Pulse Modulation trigger is received from the M9310A Trig 1 connector.
<b>Trig 2</b>	This SMB male connector is the Synchronization Output Trigger.
<b>Sync</b>	This connector is intended for future use.
<b>RF Out</b>	This SMA female connector outputs a modulated RF signal of 1 MHz to 3 or 6 GHz. This signal is routed to the M9310A RF In connector.

**CAUTION** Do not remove or re-torque any of the four IQ cables at the bottom of the module.

# M9381A Block Diagram

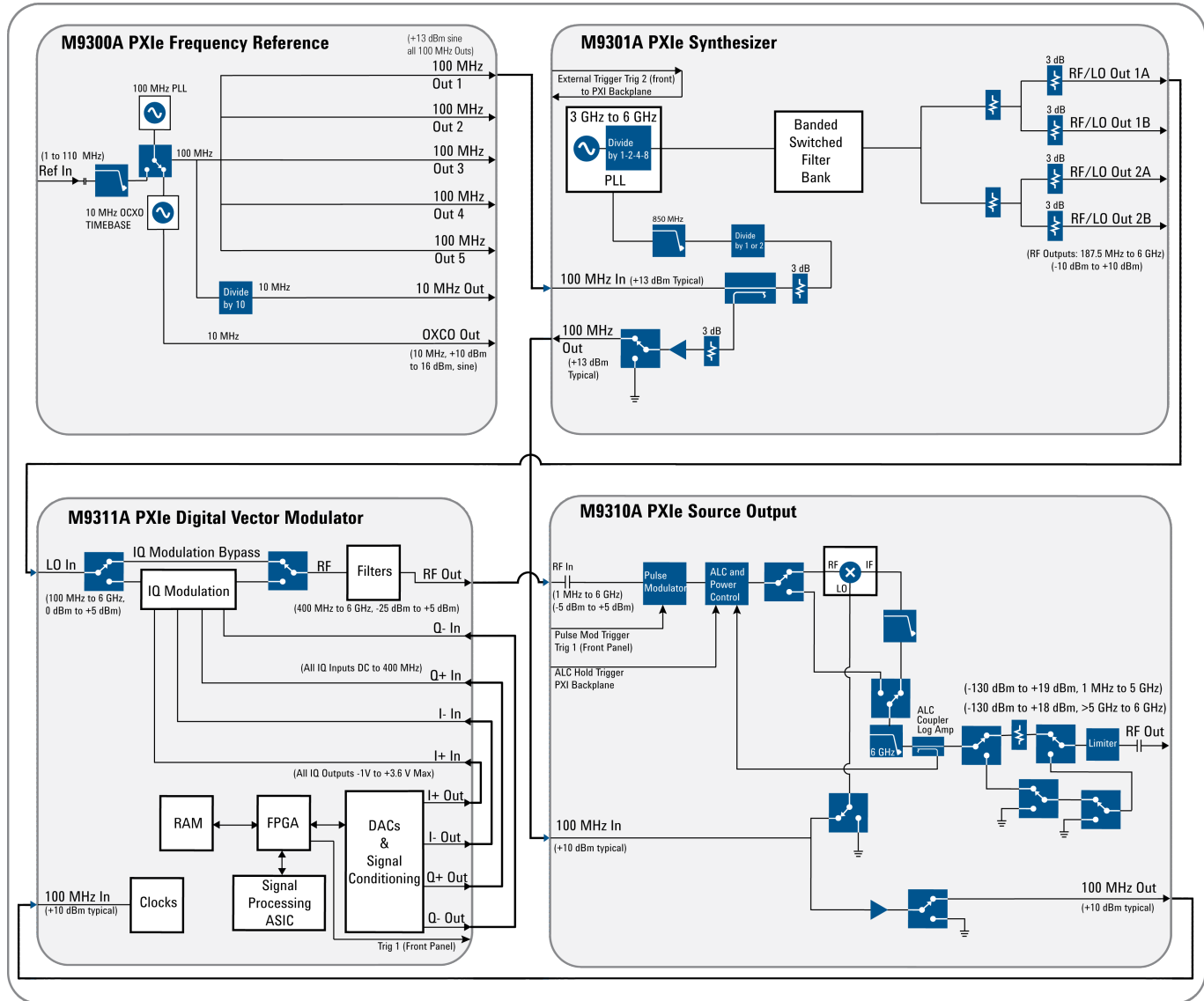

**M9381A Block Diagram Reference Table for M9300A**

<b>M9300A PXIe Reference Operation</b>		
<b>Input</b>	<b>Connector</b>	<b>Output</b>
From: External Reference Frequency: 1 MHz to 110 MHz Input Level: -5 dBm to +20 dBm	Ref In	
	100 MHz Out 1-5	Frequency: 100 MHz Output level: >+12 dBm sine (+13 dBm typical)
	10 MHz Out	Output level: 3.3 Vpp square (1.65 v into 50 Ω)
	OCXO Out	Frequency: 10 MHz, AC coupled , 50 Ω source. Output level: +10 dBm to +16 dBm, from 10 MHz OCXO.
	Sync	This connector is intended for future use.
Sine or square wave -2 V to +5 V max into 50 Ω, +16 dBm max @ 0 VDC into 50 Ω	Trigger 1 & 2 (In/Out)	3.3 V into 50 Ω
From : Chassis back plane board Frequency: 100 MHz	100 MHz BP Out	Frequency: 100 MHz Output level: +10 dBm

**M9381A Block Diagram Reference Table for M9301A**

<b>M9301A PXIe Synthesizer Operation</b>		
<b>Input</b>	<b>Connector</b>	<b>Output</b>
	RF/LO Out 1A, 1B, 2A, 2B	Frequency: 187.5 MHz to 6.0 GHz Output level: -10 dBm to +10 dBm
From: M9300A 100 MHz Out - frequency: 100 MHz, Amplitude: >+12 dBm @100 Hz: -130 dBc/Hz @1 kHz: -160 dBc/Hz	100 MHz In	
	100 MHz Out	From: M9301A 100 MHz In Frequency: 100 MHz Output level: >+10 dBm (typical)
	Sync	This connector is intended for future use.
Sine or square wave -2 V to +5 V max into 50 Ω, +16 dBm max @ 0 VDC into 50 Ω	Trigger 1 & 2 (In/Out)	3.3 V into 50 Ω
Chassis back plane board	100 MHz BP Out	Frequency: 100 MHz Output level: >+10 dBm



M9381A Block Diagram Reference Table for M9310A

M9310A PXIe RF Output Operation		
Input	Connector	Output
From M9311A DVM RF Out Frequency: 100 MHz to 6 GHz Input level: -25 dBm to +5 dBm	RF In	
	RF Out	Frequency: 1 MHz to 6 GHz Output level: -120 dBm to +10 dBm (standard power) Output level: +19 dBm (Option 1EA high power) for frequencies up to 2.5 GHz and +18 dBm for frequencies > 2.5 GHz to 6 GHz.
from: M9301A 100 MHz Out Frequency: 100 MHz Amplitude: >+12 dBm	100 MHz In	
	100 MHz Out	To M9311A 100 MHz In Frequency: 100 MHz Output level: >+10 dBm (typical)
	Sync	This connector is intended for future use
Sine or square wave -2 V to +5 V max into 50 $\Omega$ , +16 dBm max @ 0 VDC into 50 $\Omega$	Trigger 1 & 2 (In/Out)	3.3 V into 50 $\Omega$ . Trig 1 Output to M9311A Trig 1.
Chassis back plane board	100 MHz BP Out	Frequency: 100 MHz Output level: >+10 dBm

M9381A Block Diagram Reference Table for M9311A

M9311A PXIe Digital Vector Modulator Operation		
Input	Connector	Output
From: M9301A Synthesizer RF/LO Out. Frequency: 187.5 MHz to 6 GHz Input level: 0 dBm to +5 dBm	LO In	
	RF Out	Frequency: 187.5 MHz to 6 GHz Output power: -125 dBm to +5 dBm to M9310A RF In
100 MHz Reference from M9301A	100 MHz In	
	Sync	This connector is intended for future use.
Sine or square wave -2 V to +5 V max into 50 $\Omega$ , +16 dBm max @ 0 VDC into 50 $\Omega$	Trigger 1 & 2 (In/Out)	3.3 V into 50 $\Omega$ Trig 1. Input from M9310A trig 1

## Step 5: Verify Operation of the Agilent M9381A PXIe Vector Signal Generator

In this step you will verify correct operation of the Agilent M9381A PXIe Vector Signal Generator. Before running a Self Test or performing a Calibration, assure that all required software is installed, the chassis is powered on, and all cabling is correct. See "[M9381A Instrument Connections](#)" on page 16 for proper cabling.

The first step in this process is to conduct a Self Test of the M9381A.

1. Open the M9381A soft front panel (SFP) by selecting **Start > All Programs > Agilent > M938x > M9381A SFP**.
2. Upon opening the SFP, you are presented with the "Connect to Instrument" dialog. Select all the modules that are components of the M9381A and press **Connect**. For example:

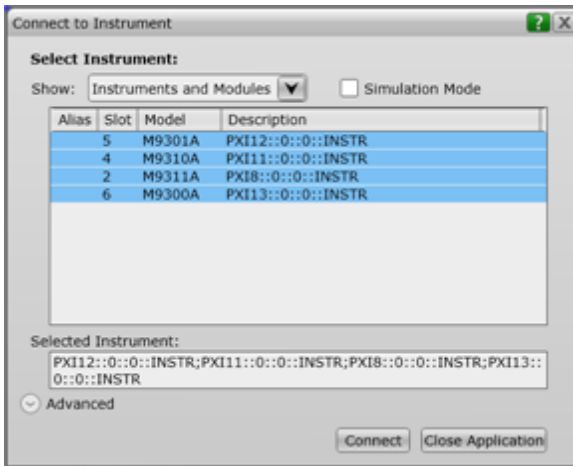

**NOTE** If no modules are visible in the SFP "Connect to Instrument" dialog, see "[Communications](#)" on page 28.

3. Conduct a Self Test (**Utilities > Self Test... > Run Self Test**). The M9381A Self Test runs each module through its own Self Test.

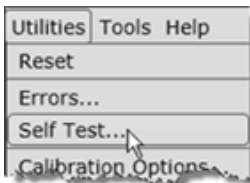

If the Self Test passes (see results below), go to [Step 6: Installation is Complete](#) (page 27).

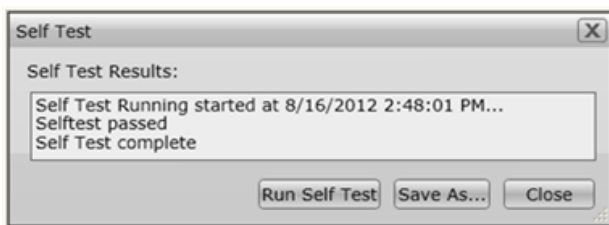

**CAUTION**

If the M9381A Self Test fails, it indicates which module is likely to need service. See "[M9381A Troubleshooting](#)" on page 28 to ascertain the source of the failure.

**NOTE**

If the Self Test reports backplane trigger errors, follow the PXI trigger bus reconfiguration instructions in [Configuring M9018A PXIe Backplane Triggers](#) (page 35).

## Step 6: Installation is Complete

Proceed to program your product by means of the application programming interface (API) for the supplied drivers.

### API Overview

#### IVI Drivers

Agilent's IVI drivers simplify the creation and maintenance of instrument control applications in a variety of development environments; they allow programmatic control of instrumentation while providing a greater degree of instrument interchangeability and code reuse. IVI drivers currently come in two basic types: IVI-COM and IVI-C. Although the functionality offered by both types of drivers is often very similar, the fundamental differences in interface technology results in a very different end-user experience. The IVI drivers support compiling application programs for 32- or 64-bit platforms.

**Supported ADEs:** Arguably the most important consideration in comparing IVI-COM and IVI-C drivers is the end user experience in various ADEs. Since IVI-COM drivers are based on Microsoft COM technology, it's not surprising that IVI-COM drivers offer the richest user experience in Microsoft ADEs. Users working in Visual C++, Visual C#, Visual Basic.NET, and Visual Basic 6 enjoy a host of features, such as object browsers, IntelliSense, and context-sensitive help.

When you install the product software, the IVI driver files are installed in the standard IVI Foundation directories (for example, C:\Program Files\IVI Foundation\IVI\Drivers\AgM938x). Example programs are provided to demonstrate most driver functionality (for example, C:\Program Files\IVI Foundation\IVI\Drivers\AgM938x Source\Examples). The reference material for the driver functions (a Microsoft HTML Help .chm file) is installed with the IVI driver and is available for Microsoft Visual Studio's IntelliSense context linking. In addition, you can directly access the chm file (AgM938x.chm) from this Start menu location: **Start > All Programs > Agilent IVI Drivers > AgM938x Source > Documentation.**

#### LabVIEW Driver

In addition to the IVI drivers, Agilent provides a LabVIEW driver that includes all the functionality of the IVI-C driver. When you install the product software, the LabVIEW driver is installed to each LabVIEW instr.lib directory for each version of LabVIEW you have on your computer. Example programs are provided to demonstrate most driver functionality. The reference information for the driver (a Microsoft HTML Help .chm file) is also installed with the driver and the content is available from LabVIEW's Context Help window. In addition, you can directly access the chm file (AgM938x\_LabVIEW\_Help.chm) from this Start menu location: **Start > All Programs > Agilent > M938x > M938x LabVIEW Help.**

## M9381A Specifications

The Specification Guide for the M9381A is included on the Software and Product Information CD (M9300-10002) that came with your instrument. This document contains specification information. Please check the Agilent website at [www.agilent.com/find/M9381A](http://www.agilent.com/find/M9381A) for the latest updates to this information. The Specifications Guide for the M9381A can also be found in PDF format at <http://cp.literature.agilent.com/litweb/pdf/M9381-90015.pdf>.

# M9381A Troubleshooting

## Communications

If you are unable to communicate with the M9381A, verify that the following installations are correct:

- Agilent IO Libraries Suite
- M9381A SFP
- Module and chassis drivers
- System Interface Card, cable and PC PXIe card connections
- If no modules are visible in the SFP "Connect to Instrument" dialog, start Agilent Connection Expert, by selecting **Start > Programs > Agilent IO Libraries Suite > Agilent Connection Expert**. If the modules are still not visible, select **Refresh All**.

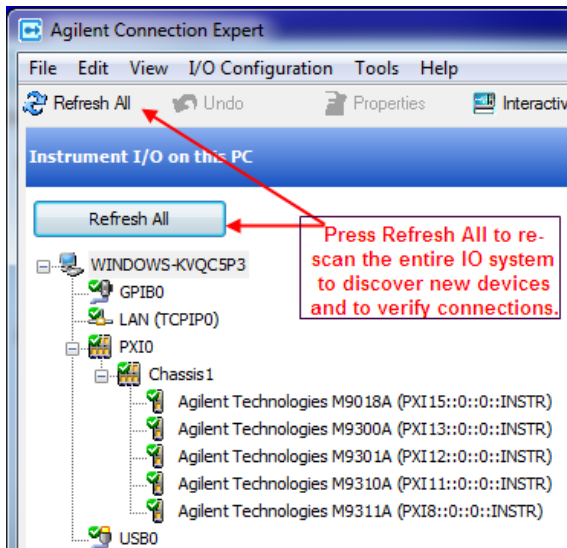

## Module-Level Troubleshooting Overview

1. Start by verifying ALL cables are properly connected and SMA connectors are torqued to 8 Lb-In (0.904 Nm). See "[M9381A Instrument Connections](#)" on page [16](#) for instrument-level cabling.
2. Check the front panel Status LEDs. See "[Status LED States](#)" on page [29](#).
3. Check the M9381A SFP Instrument Status window and Self Tests.
4. Perform a module-level troubleshooting check.

## Status LED States

**NOTE**

Once you open the M9381A SFP, select all relevant modules, and then choose **Connect**. The modules are initialized. Until a module is initialized, the LEDs are off..

Module	Green	Orange	Red	Off
<b>M9300A</b>	The Soft Front Panel has initialized the connection to the module	n/a	Indicates that the VCXO is unlocked.	<ul style="list-style-type: none"> <li>Not connected by the SFP.</li> <li>Failure in the power supplies. Module hardware health can't be determined until the power supply failure is resolved.</li> </ul>
<b>M9301A</b>	The Soft Front Panel has initialized the connection to the module	Tuning is in progress, or the M9301A is unlocked from the reference.	n/a	<ul style="list-style-type: none"> <li>Not connected by the SFP.</li> <li>Failure in the power supplies. Module hardware health can't be determined until the power supply failure is resolved.</li> </ul>
<b>M9311A</b>	<ul style="list-style-type: none"> <li>The Soft Front Panel has initialized the connection to the module.</li> <li>The module has returned to idle from modulation.</li> </ul>	<ul style="list-style-type: none"> <li>Modulation is turned on.</li> </ul>	<ul style="list-style-type: none"> <li>DAC overload detected.</li> <li>IQ overload detected</li> </ul>	<ul style="list-style-type: none"> <li>Not connected by the SFP.</li> <li>Failure in the power supplies. Module hardware health can't be determined until the power supply failure is resolved.</li> </ul>

### M9381A Soft Front Panel Self Tests

Start the SFP self tests by selecting: **Utilities > Self Test > Run Self Test**. Once completed, a dialog box appears and reports on each of the modules, indicating if it passed or failed.

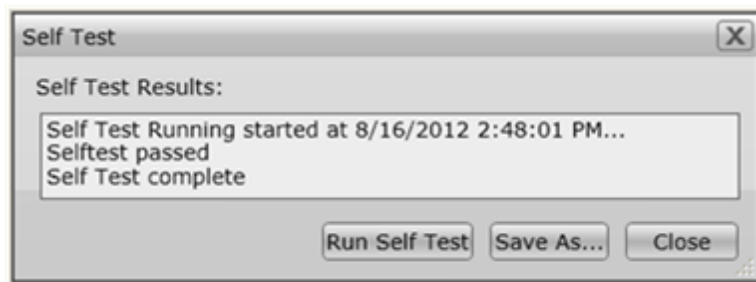

## M9300A PXIe Frequency Reference Troubleshooting

Start the soft front panel (SFP) self test by selecting **Utility > Self Test > Run Self Test**. Once completed, a dialog box appears and reports whether the MMI passed or failed Self Test.

### Recommended Hardware

Please refer to the following table for recommended hardware. Additionally, a high quality flexible 3.5 mm cable is required, plus adapters to connect the PSG (precision signal generator) and signal analyzer.

Hardware	Description	Critical parameters
Agilent N9020A Option 508 or N9030A Option 508 or E44454A	Signal Analyzer	1 MHz to 6 GHz
Agilent N5181A	Source or Function Generator	1 MHz to 110 MHz, 0 to 10 dBm

### Ref In Connector

1. On the M9381A SFP, select the “Reference” tab and under “External” select "Use External Reference.

#### NOTE

The External Reference status indicator will show an "Unlocked" condition and the Status LED on the M9300A front panel will turn red until an external reference is applied.

2. Connect an external source or function generator output to the M9300A “Ref In” connector.
3. Set the source/function generator to the first frequency and power level listed in the following table.
4. On the SFP (under External Reference) enter the external reference frequency in "Frequency".
5. Verify that the Reference is locked, using the SFP Reference Status indicators.
6. Set the source/function generator to each frequency and power level listed in the following table, and verify that the reference locks.

SFP External Reference Frequency	Source Frequency	Source Power Level (sine)
1 MHz	1 MHz	+10 dBm
1 MHz	1 MHz	0 dBm
10 MHz	10 MHz	+10 dBm
10 MHz	10 MHz	0 dBm
100 MHz	100 MHz	+10 dBm
100 MHz	100 MHz	0 dBm
110 MHz	110 MHz	+10 dBm
110 MHz	110 MHz	0 dBm

#### NOTE

Cable loss must be considered, when determining the results.

7. If the Reference remains locked at all frequencies and power levels, proceed to the next test.
8. If the Reference loses lock, the module is defective and should be repaired. See "[Return an Instrument for Service](#)" on page 9.
9. Uncheck, “Use External Reference” and remove the cable from the Ref In connector.
10. If the Reference loses lock, the module is defective and should be repaired. See "[Return an Instrument for Service](#)" on page 9.

### 100 MHz Out 1 through 5 Connectors

1. Set the signal analyzer reference level to +20 dBm, and the center frequency to 100 MHz.
2. On the SFP, under the Reference tab and under 100 MHz Reference, check Enable Out 1-5.
3. On the SFP, under External, verify that "Use External Reference" is unchecked (disabled.)
4. Connect the RF INPUT on the signal analyzer to the 100 MHz Out 1 connector on the M9300A.
5. The output level should be  $\geq 10$  dBm.
6. Measure the power out of 100 MHz Out 2 through 5 for  $\geq 10$  dBm.
7. On the SFP, disable (uncheck) 100 MHz Out 1 through 5.
8. Repeat the measurement of power on 100 MHz Out 1 through 5.
9. The power level should be  $\sim 20$  dB less than measured when the outputs were enabled.
10. If any power level fails (when enabled or disabled) the Reference module needs to be repaired. See "[Return an Instrument for Service](#)" on page 9.

### 10 MHz Out, 100 MHz BP Out and OCXO Out Connectors

1. On the SFP under the "Reference" tab, find "Miscellaneous". Select and enable 100 MHz BP, 10 MHz Out, and OCXO Out.
2. Set the signal analyzer center frequency to 10 MHz, reference level to 20 dBm and span to 1 kHz.
3. Connect the signal analyzer to 10 MHz OCXO Out on the M9300A.
4. Verify that the 10 MHz OCXO power level is  $\geq +9$  dBm.
5. Connect the signal analyzer to the 10 MHz Out connector and verify that the power is  $\geq +7$  dBm.
6. Set the signal analyzer center frequency to 100 MHz and the span to 50 kHz.
7. When the 10 MHz Out and OCXO Out controls are Enabled and there is no or low signal present, the module is defective and needs to be repaired. See "[Return an Instrument for Service](#)" on page 9.
8. Set the signal analyzer center frequency to 100 MHz and the span to 50 kHz.
9. Connect the signal analyzer to the 100 MHz BP Out connector and verify that the power is  $\geq +10$  dBm.
10. If the power level is low, the module is defective and needs to be repaired. See "[Return an Instrument for Service](#)" on page 9.

## M9301A PXIe Synthesizer Troubleshooting

This procedure requires that you:

- Install the M9301A module into an appropriate chassis with all other M9381A modules.
- Open the M9381A SFP interface.
- Connect the M9301A 100 MHz In connector to one of the M9300A 100 MHz Out (1 through 5) and enable that output from the Reference tab of the SFP.

### RF Out 1A/B, 2A/B Connectors

1. Connect the M9300A 10 MHz Out to the signal analyzer 10 MHz Ext. Ref In.
2. Under the Reference tab on the SFP:
  - a. Enable the 100 MHz Out connector that is connected to the M9301A (default state).
  - b. Under "Miscellaneous" enable the 10 MHz Out. This is the default state.

3. Verify that the signal analyzer External Reference indicator is on.
4. Connect the M9301A RF/LO Out 1A connector to the signal analyzer RF INPUT.
5. Set the signal analyzer:
  - a. Reference level: +20 dBm
  - b. Span: 500 MHz
  - c. Reference bandwidth and resolution bandwidth to Auto.
  - d. Center Frequency: 1 GHz
6. Set the M9381A, using the SFP, and the signal analyzer to the first of the frequencies listed below:
  - 1.0 GHz
  - 2.0 GHz
  - 3.0 GHz

The following frequencies apply only to Option F06 (6 GHz frequency range):

- 3.05 GHz
  - 5.0 GHz
  - 6.0 GHz
7. On the signal analyzer, verify that the power level out of RF/LO Out 1A and 1B is  $\geq -3$  dBm at all frequencies in Step 6.
  8. Also, verify that the power level out of RF/LO Out 2A and 2B is  $\geq -13$  dBm at all frequencies in Step 6.
  9. If any RF/LO Out connector fails to provide a signal or a signal within the limits, the M9301A needs to be repaired. See "[Return an Instrument for Service](#)" on page 9.

---

**NOTE**

Cable loss must be considered, when determining the results.

---

### 100 MHz In, and 100 MHz Out

1. On the SFP Reference tab, verify that the 100 MHz Out 1 Enabled box is checked.
2. Set the signal analyzer to 100 MHz and the reference level to +20 dBm.
3. Connect the signal analyzer to the M9301A 100 MHz Out connector and verify that the signal level is  $>+10$  dBm.
4. On the SFP Reference Tab, deselect 100 MHz Out.
5. The 100 MHz signal on the signal analyzer should decrease by  $\sim 20$  dB.
6. Re-enable 100 MHz Out and the 100 MHz signal should reappear.
7. Remove the M9301A 100 MHz In and the 100 MHz signal on the signal analyzer should disappear.
8. Reconnect the 100 MHz input from the M9300A.
9. Verify that the signal returns.
10. If the module fails any of the above tests, it needs repair. See "[Return an Instrument for Service](#)" on page 9.



## M9310A PXIe Source Output Troubleshooting

---

**NOTE**

Before proceeding, check the outputs of the M9301A and M9311A (if applicable).

---

1. Verify that all module interconnect cables are properly connected. See "[M9381A Instrument Connections](#)" on page [16](#).
2. Set the signal analyzer to
  - a. Reference level: 30 dBm
  - b. Span: 1 MHz
  - c. Reference Bandwidth and Resolution Bandwidth set to "Auto"
3. Using the SFP, set the Amplitude to +10 dBm for a standard instrument or +19 dBm for a high power instrument (Option 1EA), turn RF On, and ALC On.
4. Connect the M9310A RF Out to the signal analyzer RF In.
5. Using the list below, set the SFP and signal analyzer frequencies and verify the power levels. A Standard M9310A should have an output of +10 dBm. An M9310A with High Output Power Option 1EA should have an output of +19 dBm for frequencies up to 2.5 GHz, and +18 dBm for frequencies above 2.5 GHz.

**NOTE**

Cable loss must be considered, when determining the results.

---

- 1 MHz
  - 390 MHz
  - 1.0 GHz
  - 3.0 GHz
  - 6.0 GHz (This frequency applies only to an M9310A with High Frequency Option F06.)
6. If the module fails at any frequency, it is defective and needs repair. See "[Return an Instrument for Service](#)" on page [9](#).

## M9311A PXIe Digital Vector Modulator Troubleshooting

This procedure requires that :

- The M9301A outputs pass the troubleshooting procedure before troubleshooting the M9311A.
- The M9311A is installed in a chassis with an Agilent M9300A PXIe Frequency Reference, an Agilent M9301A PXIe Synthesizer, and an Agilent M9310A PXIe Source Output and cabled. See "[M9381A Instrument Connections](#)" on page [16](#).
- The M9381A SFP is active.

---

**NOTE**

Modulation On is the default state of the SFP.

---

1. From the SFP, set the Amplitude to +10 dBm.
2. Set the signal analyzer reference level to +20 dBm.
3. Remove the semi-rigid cable from the M9311A RF Out to the M9310A RF In.
4. Connect the M9311A RF Out to the signal analyzer RF INPUT.
5. Using the list below, set the spectrum analyzer and M9381A SFP frequencies and verify that the power out of the M9311A is > -10 dBm.
  - 1.0 GHz
  - 2.0 GHz
  - 3.0 GHz

The following frequencies apply only to Option F06 (6 GHz frequency range):

- 3.05 GHz
  - 4.5 GHz
  - 6.0 GHz
6. If the modules fails at any frequency, it is defective and needs repair. See "[Return an Instrument for Service](#)" on page [9](#).

## Configuring M9018A PXIe Backplane Triggers

When using the Agilent M9018A PXIe 18-slot chassis, it is recommended that you install the M9381A modules entirely within one of the slot groups: 1 through 6, 7 through 12, or 13 through 18. If you install the M9381A modules straddling any these groups of slots, you will have to reconfigure the chassis's PXIe trigger bus routing for trigger 6 and trigger 7. (**EXCEPTION:** You can install the M9300A Reference module in a different slot group, thus allowing one M9300A module to provide an RF reference across slot groups to one or more modular instruments.)

### Backplane Triggers Used

- PXIe backplane trigger 6 is used to route the External Trigger signal from the Agilent M9301A PXIe Synthesizer to the Agilent M9311A PXIe Digital Vector Modulator.
- PXIe backplane trigger 7 is used for routing the ALC Trigger signal from the Agilent M9311A PXIe Digital Vector Modulator to the Agilent M9310A PXIe Source Output. Although the default is PXIe trigger 7, PXIe triggers 1 through 7 could be used based on the ALC Trigger Source selection in the AgM938x driver.

#### CAUTION

The Agilent M9018A PXIe Chassis does not remember the trigger bus configuration upon cycling power. After a power cycle, you must reconfigure the bus triggers by using the M9018A SFP or by creating a persistent configuration by using the AgM9018 API.

### Procedure for Configuring PXIe Backplane Bus Triggers

1. Make sure you have followed Steps 1 through 6 in this Startup Guide to setup, configure, and verify installation of the Agilent M9381A PXIe Vector Signal Generator.
2. Conduct a Self Test (**Utilities > Self Test... > Run Self Test**). If your configuration straddles two slot groups, you will receive error messages.

#### NOTE

In the following graphic a Self Test has been run on an M9381A that is installed in slots 5 through 9; therefore, it straddles two slot groups. It detects errors with backplane triggers 6 and 7.

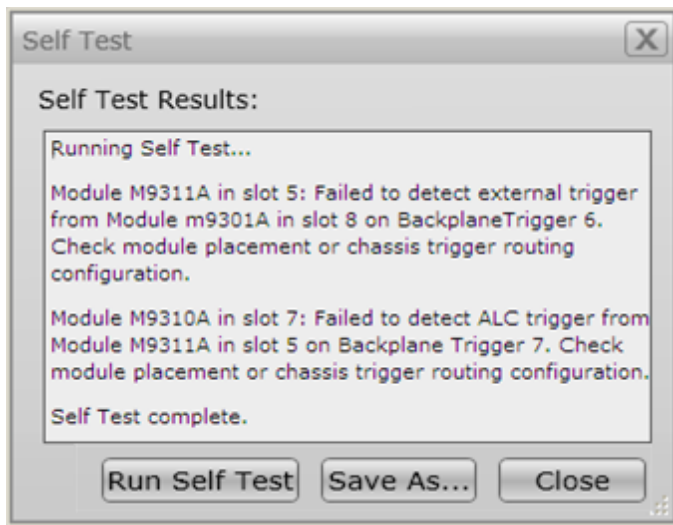

## Configuring M9018A PXIe Backplane Triggers

- Open the M9018A SFP (**Start > All Programs > Agilent > M9018 > M9018 SFP**).
- Select (enable) **Allow Control**.

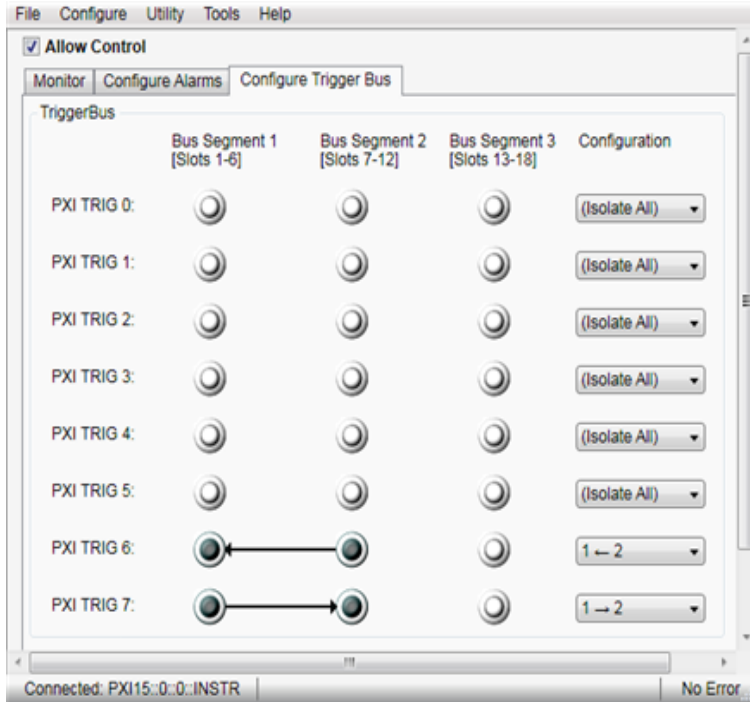

- Trigger 6 routes the External Trigger signal from the M9301A to the M9311A. In this example, the M9301A has been installed in Slot 8 (Bus Segment 2), while the M9311A is in Slots 5 (Bus Segment 1). Therefore, backplane trigger 6 must be redirected from Bus Segment 2 to Bus Segment 1. Use the drop-down menu to select "1 ← 2".
- Trigger 7 routes the ALC Trigger signal from the M9311A to the M9310A. Since the M9311A is now in Bus Segment 1 and the M9310A is in Bus Segment 2, backplane trigger 7 must be redirected from Bus Segment 1 to Bus Segment 2. Use the drop-down menu to select "1 → 2".

### NOTE

If two sources are installed in the M9018A chassis, each source should have its own backplane trigger line. If you have a source that spans segment 1 and segment 2 and another source that spans segment 2 and segment 3, using a single set of trigger lines with 1 → 2 → 3 and 1 ← 2 ← 3 does not work for both sources. In this case, you must configure one set of trigger lines with 1 → 2 and 1 ← 2 connections and another set of trigger lines with 2 → 3 and 2 ← 3 connections.





## The Modular Tangram

The four-sided geometric symbol that appears in Agilent modular product literature is called a tangram. The goal of this seven-piece puzzle is to create shapes—from simple to complex. As with a tangram, the possibilities may seem infinite as you begin to create a new test system. With a set of clearly defined elements—hardware, software—Agilent can help you create the system you need, from simple to complex.



**DISCOVER** the Alternatives ...

... Agilent **MODULAR** Products



**Agilent Advantage Services** is committed to your success throughout your equipment's lifetime.  
[www.agilent.com/find/advantageservices](http://www.agilent.com/find/advantageservices)



**Agilent Email Updates** keep you informed on the latest product, support and application information.  
[www.agilent.com/find/emailupdates](http://www.agilent.com/find/emailupdates)



**Agilent Channel Partners** provide sales and solutions support. For details, see  
[www.agilent.com/find/channelpartners](http://www.agilent.com/find/channelpartners)

Agilent Electronic Measurement Group



ISO 9001:2008 certified. For details, see  
[www.agilent.com/quality](http://www.agilent.com/quality)

**PXI** [www.pxisa.org](http://www.pxisa.org)

PICMG and the PICMG logo, CompactPCI and the CompactPCI logo, AdvancedTCA and the AdvancedTCA logo are US registered trademarks of the PCI Industrial Computers Manufacturers Group. "PCIe" and "PCI EXPRESS" are registered trademarks and/or service marks of PC-SIG. Microsoft, Windows, Visual Studio, Visual C++, Visual C#, and Visual Basic are either registered trademark or trademarks of Microsoft Corporation.

Product descriptions in this document are subject to change without notice.

© Agilent Technologies, Inc. 2010-2013

[www.agilent.com](http://www.agilent.com)

[www.agilent.com/find/modular](http://www.agilent.com/find/modular)

[www.agilent.com/find/M9381A](http://www.agilent.com/find/M9381A)

For more information on Agilent Technologies' products, applications or services, please contact your local Agilent office. (For additional listings, go to [www.agilent.com/find/assist](http://www.agilent.com/find/assist).)

### Americas

Canada	(877) 894 4414
Brazil	(11) 4197 3500
Mexico	01800 5064 800
United States	(800) 829 4444

### Asia Pacific

Australia	1 800 629 485
China	800 810 0189
Hong Kong	800 938 693
India	1 800 112 929
Japan	0120 (421) 345
Korea	080 769 0800
Malaysia	1 800 888 848
Singapore	1 800 375 8100
Taiwan	0800 047 866
Thailand	1 800 226 008

### Europe & Middle East

Austria	43 (0) 1 360 277 1571
Belgium	32 (0) 2 404 93 40
Denmark	45 70 13 15 15
Finland	358 (0) 10 855 2100
France	0825 010 700 (0.125 €/minute)
Germany	49 (0) 7031 464 6333
Ireland	1890 924 204
Israel	972 3 9288 504 / 544
Italy	39 02 92 60 8484
Netherlands	31 (0) 20 547 2111
Spain	34 (91) 631 3300
Sweden	0200 88 22 55
Switzerland	0800 80 53 53
United Kingdom	44 (0) 118 9276201



**Agilent Technologies**